



memmert
Experts in Thermostatics

Climate chambers

ALWAYS AN EYE ON LONG-TERM STABILITY.



CONSTANT CLIMATE CHAMBER HPP

HUMIDITY CHAMBER HCP

CLIMATE CHAMBER ICH

ENVIRONMENTAL TEST CHAMBER CTC/TTC

100% ATMOSAFE. MADE IN GERMANY.

www.memmert.com | www.atmosafe.net



Reliable. Precise. 100% AtmoSAFE.

Perfect simulation of reality.
Reproducible, standard compliant, economic.

Each climate chamber creates a climate of temperature and humidity. For Memmert climate chambers, however, that is not enough. Each individual climate chamber is perfectly designed for the high requirements of stability and climate tests, conditioning or ageing. In each individual appliance, there is a homogenous and stable temperature and humidity distribution over the entire chamber. Operation, programming and documentation options feature top-notch convenience. Each individual Memmert climate chamber complies with the strict requirements of DIN 12880:2007-05 and is equipped with a maximum of safety functions. Each individual Memmert climate chamber is 100% AtmoSAFE.



CONSTANT CLIMATE CHAMBER HPP

PAGE 4 TO 5

TECHNICAL DATA

PAGE 6 TO 7

Stability testing (according to ICH Q1A) in the pharmaceutical industry, long-term storage, growing plants, conditioning and climate testing of plastic material/metal/composite material, storage of electronic components/lacquers/coatings in controlled environment

HUMIDITY CHAMBER HCP

PAGE 8 TO 9

TECHNICAL DATA

PAGE 10 TO 11

Conditioning and climate testing of plastic material/metal/composite material, stability testings in the pharmaceutical industry, storage of electronic components/lacquers/coatings in controlled environment

CLIMATE CHAMBER ICH

PAGE 12 TO 13

TECHNICAL DATA

PAGE 14 TO 15

Stability testing (according to ICH Q1A) and photostability testing (according to ICH Q1B) in the pharmaceutical industry, long-term storage, conditioning and climate testing of plastic material/metal/composite material, storage of electronic components/lacquers/coatings in controlled environment

CLIMATIC TEST CHAMBER CTC

TEMPERATURE TEST CHAMBER TTC

PAGE 16 TO 17

TECHNICAL DATA

PAGE 18 TO 19

Accelerated and intermediate tests, alternate stability testing, conditioning and climate-/temperature testing of plastic material/metal/composite material, storage of electronic components/lacquers/coatings in controlled environment with/without humidity

DECISION-MAKING-AID

PAGE 20

Decision-making-aid for appliances with controlled humidity

OPTIONS AND ACCESSORIES

PAGE 20 TO 22

Options and accessories available for all products

FEATURES MODEL VARIANTS

PAGE 23

SingleDISPLAY and TwinDISPLAY



Constant climate chamber HPP
with TwinDISPLAY
AtmoCONTROL software

Model sizes: 110 / 260 / 400 / 750 / 1060
0 °C to +70 °C (without humidity)
+5 °C to +70 °C (with humidity)
Humidity 10 to 90 % rh
optional with LED light module
(sizes 110, 260, 400, 750)

Model size 1400
+15 °C to +60 °C (with and without humidity)
Humidity 10 to 80 % rh

CONSTANT CLIMATE CHAMBER HPP They are simply unbeatable in energy efficiency. Furthermore, as constant climate chambers HPP have a very long, almost maintenance free service life, they are perfectly suited for stability tests, storage in controlled environment and conditioning. The high precision temperature control as well as the active humidification and dehumidification were particularly adapted to the ICH guidelines, option Q1A, for stability tests.





The best climate for samples, environment and budget

Almost without vibrations and extremely quiet, the specially adapted Peltier technology heats up and cools down seamlessly in one system. In this respect, the innovative constant climate chamber HPP not only contributes to climate protection, but it also achieves an additional decrease in operating costs of up to 90 % compared to compressor technology.



Cost effective climate protection

The main part of stability testing is performed at temperatures between +20 °C and +30 °C – close to the ambient temperature. The impressive cost effectiveness of Peltier technology can be seen here, since only small amounts of energy are required to raise or lower the temperature slightly, in comparison with compressor technology. Due to its environmentally friendly Peltier elements, the HPP has no need for coolants and requires no regular maintenance.

Comparison between compressor and Peltier technology

Reduction in energy consumption of up to 90 %

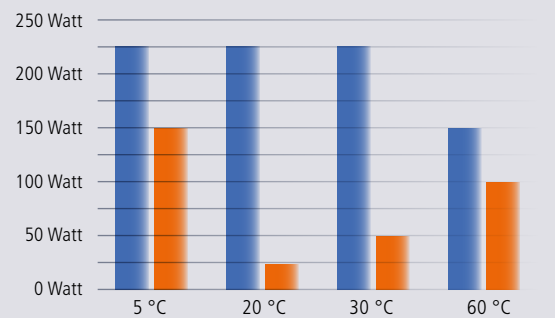
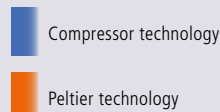

Top level optimisation

The outstanding precision of the constant climate chambers was optimised with the introduction of our new appliances. If required, the Peltier elements can be controlled individually to ensure even more homogenous temperature and humidity distribution inside the chamber.

For supporting IQ/OQ/PQ validation, temperature and humidity control can be adjusted directly on the ControlCOCKPIT with three free-selectable measuring points.

LED light modules

Dimmable LED light protects the environment, reduces energy consumption and ensures ideal conditions of growth. Available alternatives: Cold-white light (6,500 K), warm-white light (2,700 K) or cold-white plus warm-white light, dimmable in 1 % steps, for HPP110 – HPP750.

Note: Within the respective temperature-humidity range, condensation-free permanent operation is possible. To which extent condensation may occur in the threshold range depends on the humidity content of the chamber load and the ambient conditions.

Temperature-humidity working range

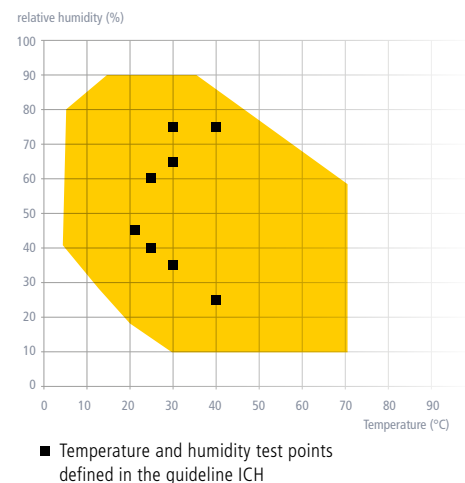

CONSTANT CLIMATE CHAMBERS HPP

according to DIN 12880:2007-05, EN 61010-1 (IEC 61010-1), 61010-2-010

Standard units are safety-approved and bear the test marks:
(EAC not valid for HPP400/1060/1400)



Standard equipment

Interior:	Stainless steel, mat. 1.4301 (ASTM 304), deep-drawn
Internals:	Stainless steel grids, electropolished (up to size 1060: 2; size 1400: 4)
Housing:	Textured stainless steel, rear zinc-plated steel, intuitively operated TwinDISPLAY (TFT colour display) with touchscreen
Double doors:	Outside stainless steel, fully insulated, inside glass (size 1400 stainless steel doors with glass sectors, fully heated inner glass panes integrated in the full-sight glass door with 2-point locking – compression door lock). Sizes 750, 1060 and 1400 two leaves
Connection:	Mains cable with plug
Installation:	4 feet; sizes 400, 750, 1060 and 1400 mounted on lockable castors

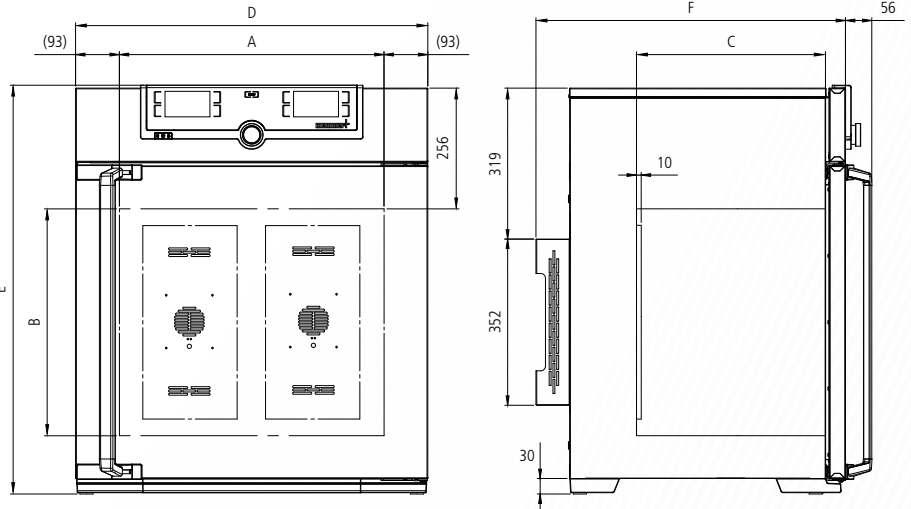

HPP110:	2 Peltier elements in the rear
HPP260:	3 Peltier elements in the rear
HPP400:	5 Peltier elements in the rear
HPP750/HPP1060:	6 Peltier elements in the rear
HPP1400:	10 Peltier elements in the rear

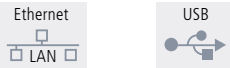

Model sizes/Description			110	260	400	750	1060	1400	
Stainless steel interior	Volume	approx. l	108	256	384	749	1060	1360	
	Width	(A) mm	560	640	640	1040	1040	1250	
	Height	(B) mm	480	800	1200	1200	1200	1450	
	Depth (less 10 mm for fan – Peltier)	(C) mm	400	500	500	600	850	750	
	Stainless steel grids, electropolished (standard equipment)	number			2			4	
	Max. number of grids/shelves	number	5	9		14		28	
	Max. loading per grid/shelf	kg		20		30	20	30	
	Max. loading of chamber	kg	150		200			250	
Textured stainless steel exterior	Width	(D) mm	745	824	824	1224	1224	1435	
	Height (sizes 400, 750, 1060 and 1400 with castors)	(E) mm	864	1183	1720	1726	1661	1968	
	Depth (without door handle), door handle + 56 mm	(F) mm	674	774	788	874	1139	1055	
Further data	Electrical load at 230/115 V, 50/60 Hz	approx. W	650	920	1200	1400	1500	3100	
	Working-temperature range without light, without humidity	°C	0 (at least 20 below ambient temperature) to +70						+15 (at least 10 below ambient to +60)
	Working-temperature range without light, with humidity	°C	+5 (at least 20 below ambient temperature) to +70						
	Working-temperature range with light, without or with humidity	°C	+15 to +40						–
	Setting temperature range without light, without humidity	°C	0 to +70						+15 to +60
	Setting temperature range without light, with humidity	°C	+5 to +70						+15 to +60
	Setting temperature range with light, without humidity	°C	0 to +70						–
	Setting temperature range with light, with humidity	°C	+5 to +70						–
	Setting accuracy temperature	°C	0.1						
	Setting range humidity without light/with light	% rh	10 to 90/10 to 85						10 to 90/– 10 to 80/–
	Setting accuracy humidity	% rh	0.5						
Standard accessories	Water tank including connection hose						□		
Packing data	Net weight	approx. kg	77	122	160	208	260	450	
	Gross weight (packed in carton)	approx. kg	102	173	213	279	424	639	
	Width	approx. cm	83	93	93	133	137	156	
	Height	approx. cm	105	138	193	191	197	220	
	Depth	approx. cm	80	93	93	105	130	119	
Order No. Constant Climate Chambers			HPP110	HPP260	HPP400	HPP750	HPP1060	HPP1400	

Options	110	260	400	750	1060	1400
Voltage 115 V, 50/60 Hz			X2			–
Chamber modification for the application of reinforced perforated stainless steel shelves or stainless steel grids (bearing rails mounted in the working chamber) – includes replacement of 2 standard grids by 2 reinforced grids		–		K1		–
Light module cold white 6,500 K: light strips arranged on the side walls of the interior, 10 for model 110, 14 for model 260/400/750, programme-controlled dimming from 0 to 100 % (in 1 % steps), ramp programming in combination with temperature and humidity			T7			–
Light module cold white 6,500 K + warm white 2,700 K: LED light strips – 10 for model 110 to 14 for model 260/400/750 – (5 resp. 7 alternating cold white light strips and 5 resp. 7 warm white light strips) on the side walls of the interior, programme-controlled dimming from 0 to 100 % (in 1 % steps), ramp programming in combination with temperature and humidity			T8			–
Light module warm white 2,700 K: light strips arranged on the side walls of the interior, 10 for model 110, 14 for model 260/400/750, programme-controlled dimming from 0 to 100 % (in 1 % steps), ramp programming in combination with temperature and humidity			T9			–
Interior socket, ampacity 230 V/2.2 A, can be switched off with the On/Off switch, cannot be switched individually, moisture tight IP68			R3			–
Entry port, 23 mm clear diameter, for introducing connections at the side, moisture tight, can be closed by flap and silicone stopper, standard positions (F0 und F2 not for model size 260 with light module; F0 – F3 not for model size 110 with light module)				F0 left centre/centre F1 left centre top F2 right centre/centre F3 right centre top		– – – –
Entry port, 23 mm clear diameter for introducing connections, moisture tight, can be closed by flap and silicone stopper (please, state location)				F4 left F5 right F6 rear		– –
Entry port (silicone), 40 mm clear diameter, for introducing connections, moisture tight, can be closed by silicone stopper, at the back (please, state location)				F7		–
4 – 20 mA current loop interface (-10 to +80 °C \pm 4 to 20 mA)						
Temperature of a Pt100 sensor positioned flexibly in chamber for external temperature monitoring (max. 3 TwinDISPLAY)				V3 V6		
Humidity controller, actual value (0 – 100 % rh \pm 4 – 20 mA)				V7		
Works calibration certificate for one (freely selectable) temperature and humidity value Standard works calibration certificate (measuring point chamber centre) at +10 °C, +37 °C as well as 60 % rh at +30 °C (sizes 1060/1400 for +25 °C/40 % rh and +40 °C/75 % rh)				D00105		
Compressed air dehumidification (efficient dehumidification of the interior by means of compressed air) Standard works calibration certificate (measuring point chamber centre) at +10 °C with 10 % rh				C9		–

Accessories	110	260	400	750	1060	1400
Stainless steel grid, electropolished (standard equipment)	E20165		E28891	E20182	B41251	B38955
Additional reinforced stainless steel grid, electropolished, max. loading 60 kg; size 750 with guide bars and fixing screws (only in connection with option K1). Please consider max. loading of chamber	E29767		E29766	B32190		–
Perforated stainless steel shelf	B00325		B29725	B00328	B32549	–
Additional reinforced stainless steel shelf, max. loading 60 kg; with guide bars and fixing screws (only in connection with option K1). Please consider max. loading of chamber		–		B32191		–
Stainless steel slide-in drip tray, 15 mm rim (may affect the temperature distribution) – cannot be used in connection with option K1	E02073		E29726	E02075	B32599	–
Max. loading per slide-in drip tray (kg)	3		4	8		–
Stainless steel slide-in drip tray, 15 mm rim, with guide bars and fixing screws (can be used only in connection with option K1)		–		B32763		–
Stainless steel bottom drip tray, 15 mm rim (may affect the temperature distribution) – cannot be used in connection with option K1	B04359		B29722	B04362	B29769	–
Max. loading per bottom drip tray (kg)	3		4	8		–
Stainless steel bottom drip tray, 15 mm rim (can be used only in connection with option K1)		–		B34055		–
Holder for water tank (sizes 110 - 750: 2,5 litres, sizes 1060/1400: 10 litres) for mounting on the rear of the appliance. Standard equipment for sizes 750, 1060 and 1400			E32172			–
Central water supply with filter cartridges for connection to the domestic water supply Product information on demand				ZWVR6		
Central water supply without filter cartridges for connection to the domestic water supply (only for demineralised water in accordance with VDE 0510/DIN EN 50272). Product information on demand				ZWVR7		
Guarantee extension by 1 year	GA1Q5			GA2Q5		GA2Q5

Further options/accessories see pages 20 - 22.

Not all options/accessories are combinable with each other. Please contact us for individual combination requests.



Humidity chamber HCP
"Celsius" standard software

Model sizes: 108 / 153 / 246
+20 °C to +90 °C (with humidity)
+20 °C to +160 °C (without humidity)
Humidity 20 to 95 % rh

HUMIDITY CHAMBER HCP Applications for humidity chambers range from construction physics to corrosion testing and down to biological research. Ramp programming for temperature and humidity, active humidity control between 20 % and 95 % rh as well as exact temperature control of up to +90 °C ensure a controlled, physiologically ideal environment for the simulation of real conditions. Without humidity, the temperature in humidity chambers HCP can be controlled to up to +160 °C.





Homogeneity in the chamber

Heating the working chamber from all six sides is essential for preventing condensation. An aluminium thermal conduction layer supports the optimal temperature distribution, and serves as a heat accumulator in case of a temporary power failure. Turbulence-free ventilation additionally supports the homogenous atmosphere in the working chamber.



Germ-free through sterilisation

Particularly in highly-sensitive applications with organic chamber loads, hygiene is the decisive factor. Cross contamination must be excluded. Therefore, the chamber including ventilation system and all sensors can be sterilised in a 4-hour programme at +160 °C.

Ramp programming

Essential for the exact simulation of environmental conditions in research: user-friendly ramp programming. Thanks to the "Celsius" standard software, an unlimited amount of different set values of temperature and humidity can be combined on time ramps.

Ramp programming

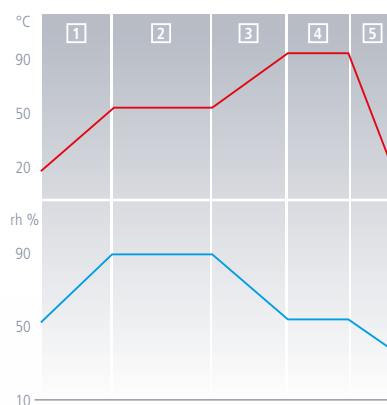

Temperature-humidity working range

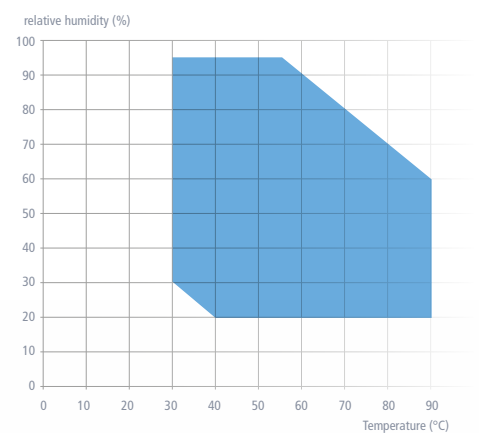

Note: Within the respective temperature-humidity range, condensation-free permanent operation is possible. To which extent condensation may occur in the threshold range depends on the humidity content of the chamber load and the ambient conditions.

HUMIDITY CHAMBERS HCP

with automatic sterilisation

(with all interior fittings incl. humidity sensor sterilised inside the humidity chamber!)

according to DIN 12880:2007-05, EN 61010-1 (IEC 61010-1), 61010-2-010

Standard units are safety-approved and bear the test marks:



Standard equipment

- Interior: Stainless steel, material 1.4301 (ASTM 304), deep-drawn, electropolished
- Internals: 2 perforated stainless steel shelves
- Housing: Textured stainless steel, rear zinc-plated steel, aesthetic functional glass-stainless steel operating panel with multifunction display and input module; fully insulated stainless steel door and inner glass door

Connection: Mains cable with plug

Installation: 4 adjustable feet

Interfaces:



parallel interface



Optional

Ethernet



LAN

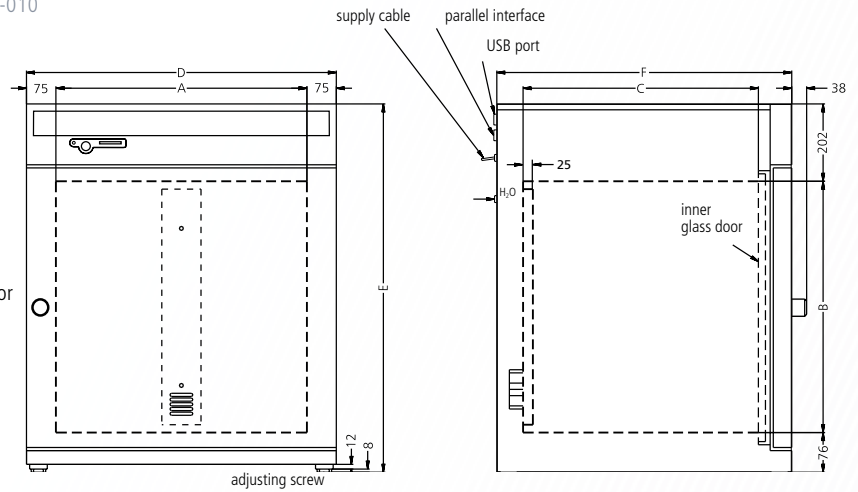

Model sizes/Description			108	153	246
Stainless steel interior electropolished	Volume	approx. l	108	153	246
	Width (A)	mm	560	480	640
	Height (B)	mm	480	640	640
	Depth (less 25 mm for fan) (C)	mm	400	500	600
	Provision for stainless steel grids or shelves	number	5	7	
Textured stainless steel exterior	Width (D)	mm	710	630	790
	Height (variable through adjustable feet) (E)	mm	778	938	938
	Depth (without door handle, door handle 38 mm) (F)	mm	550	650	750
	Fully insulated, heated stainless steel door			<input type="checkbox"/>	
	Extra internal glass door			<input type="checkbox"/>	
Ventilation	Uniform atmosphere and temperature distribution through enclosed non-turbulent ventilation system, fully covered by the sterilisation process			<input type="checkbox"/>	
Temperature	Electronic microprocessor temperature controller with Pt100 and auto-diagnostic system			<input type="checkbox"/>	
	Temperature sensors Pt100 Class A in 4-wire circuit for uninterrupted operation on failure of one Pt100 with warning indication			double	
	Temperature range with humidity control	°C	from +20 to +90 (temperature at 8 above RT to +90)		
	Temperature range without humidity control: during sterilisation the temperature is fixed at +160 °C – set value	°C	from +20 to +160 (temperature at 8 above RT to +160)		
	Temperature fluctuations with time (to DIN 12880:2007-05)	K	≤ ± 0.1		
Temperature variation in chamber at +50 °C (to DIN 12880:2007-05)	K	≤ ± 0.3			
Sterilisation	STERICard for automatic chamber sterilisation cycle 4 h at +160 °C (not for sterilising the load!)			<input type="checkbox"/>	
Humidity	Capacitive humidity sensor (sterilisable)			<input type="checkbox"/>	
	Active microprocessor control for humidifying and dehumidifying (20 – 95 % rh), incl. digital indication and auto-diagnostic system ensures even more rapid reaching of set humidity and very short recovery times while avoiding condensate formation; humidity supply with distilled water (from an external tank) by a self-priming pump; integral bacteria block by generating hotsteam, dehumidifying via sterile filter			<input type="checkbox"/>	

Model sizes/Description		108	153	246	
Monitor	Microprocessor temperature monitor acting as overtemperature protection (protection class 3.1), with Pt100 incorporating fault diagnostics with visual and audible alarm		<input type="checkbox"/>		
	Digital over- and undertemperature monitor		<input type="checkbox"/>		
	Temperature monitoring band automatically linked to the setpoint (ASF)		<input type="checkbox"/>		
	Relay for reliable heating cut-off in case of fault		<input type="checkbox"/>		
	Mechanical temperature limiter (TB)		<input type="checkbox"/>		
	Audible alarm: Over- and undertemperature, underhumidity, open door and empty water tank		<input type="checkbox"/>		
Timer functions	Real-time/weekly programmer with group function (e.g. Monday – Friday), programme operation with up to 40 ramps for temperature and humidity (MEMoryCard XL)		<input type="checkbox"/>		
Documentation	Internal log memory 1024 kB as ring memory for all setpoints, actual values, errors, settings with real-time and date; capacity approx. 3 months at 1 min intervals		<input type="checkbox"/>		
	Parallel printer interface for printing logging files, suitable for all PCL3-compatible ink jet printers (USB available via converter, see accessories on page 22)		<input type="checkbox"/>		
	"Celsius" software for control and documentation of temperature and relative humidity		<input type="checkbox"/>		
Setup	Calibration (no separate PC required), Temperature: 3-point calibration on controller, Humidity: 2-point calibration at 20 % and 90 %		<input type="checkbox"/>		
	Setting of language for dialogue and display DE / EN / ES / FR / IT		<input type="checkbox"/>		
Further data	Electrical load at 230/115 V (50/60 Hz)	approx. W	1000	1500	2000
Standard accessories	Perforated stainless steel shelves	number		2	
	Works calibration certificate (measuring point chamber centre at +60 °C)			<input type="checkbox"/>	
Packing data	Net weight	approx. kg	70	80	110
	Gross weight (packed in carton)	approx. kg	95	106	132
	Width	approx. cm	83	83	93
	Height	approx. cm	105	130	114
	Depth	approx. cm	80	80	93
Order No. Humidity Chambers			HCP108	HCP153	HCP246

Options	108	153	246
Voltage 115 V, 50/60 Hz		X2	
Door hinged on the left		B8	
Entry port, 23 mm clear diameter, for introducing connections at the side, moisture tight, can be closed by flap and silicone stopper, standard positions left centre/centre, left centre top, right centre/centre, right centre top		F0,F1,F2,F3	
Entry port (silicone), 40 mm clear diameter, for introducing connections, moisture tight, can be closed by silicone stopper, at the back (please, state location)		F7	
Works calibration certificate for 80 % rh (measured at +50 °C)		D00107	
Start-up of HCP and brief training (D, A, CH only) through Memmert service		K9	
Stacking version for 2 units of equal size (bottom unit modification)		G3	
Process-dependent electromagnetic door lock		D4	

Accessories	108	153	246
Additional perforated stainless steel shelf	B00325	B00321	B03813
Additional stainless steel grid	E20165	E20166	E29766
Subframe, adjustable in height (622 mm high)	B02792	B02732	B02793
Subframe (130 mm high for 2 stacked cabinets)	B02794	B02740	B02795
STERICard (additional or as replacement) for automatic chamber sterilisation cycle (not for sterilising the load!)		E04337	
Central water supply with filter cartridges for connection to the domestic water supply Product information on demand		ZWVR6	
Central water supply without filter cartridges for connection to the domestic water supply (only for demineralised water in accordance with VDE 0510/DIN EN 50272). Product information on demand		ZWVR7	

Further options/accessories see pages 20 - 22.

Not all options/accessories are combinable with each other. Please contact us for individual combination requests.



Climate chamber ICH
with TwinDISPLAY + AtmoCONTROL software

Model sizes: 110 / 260 / 750

ICH with humidity control

ICH L with humidity control and light

ICH C with humidity and CO₂ control

Temperature range with humidity

ICH +10 °C to +60 °C

ICH L +10 °C to +60 °C

ICH C +10 °C to +50 °C

Humidity range 10 – 80 % rh

Temperature range without humidity

ICH -10 °C to +60 °C

ICH L 0 °C to +60 °C

ICH C +10 °C to +50 °C

CLIMATE CHAMBER ICH Compressor-cooled stability test chambers developed by Memmert stand out due to their unparalleled temperature and humidity homogeneity for long-term stable ambient conditions. The climate chamber ICH has been specially designed for testing pharmaceutical products according to ICH, Q1A and Q1B, option 2, and similar global standards for stability tests of cosmetics and food.



All-round protection of samples

No icing, no drying out of samples, no dehumidification of the working chamber. Cooling aggregate and heating of the ICH are situated outside the working chamber in the air jacket surrounding the entire chamber thus ensuring quick and precise temperature control. Furthermore, the motor-driven forced air circulation, adjustable in 10 % steps, ensures particularly homogenous temperature distribution.

For supporting IQ/OQ/PQ validation, the control can be adjusted directly on the appliance:
 on models ICH, ICH L, ICH C of size 110/260: for three free-selectable values each, temperature/humidity/CO₂
 on models ICH, ICH L, ICH C of size 750: for three free-selectable values each, temperature/humidity;
 for two selectable values CO₂

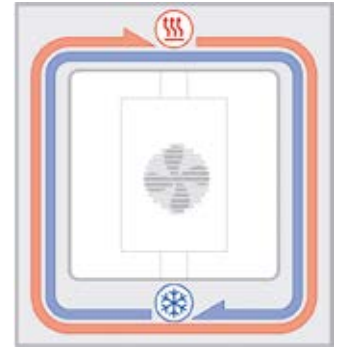

ICH air jacket system

Illumination complies with ICH Q1B, option 2

For tests in accordance with ICH Q1B, option 2, an illumination unit is available for model ICH L. Fluorescent lights with cold-white light (daylight: light colour 865, 6,500 K) as well as UV radiation in the spectral range of 320 – 400 nm, serve as light source. Daylight and UV light comply with standard illuminant D65.

Model ICH C with CO₂ control

In addition to the features of the basic model ICH, the ICH C model is equipped with an electronic CO₂ control with automatic zero setting, NDIR measurement system, auto-diagnostic system, acoustic alarm and air pressure compensation.

Temperature-humidity working range

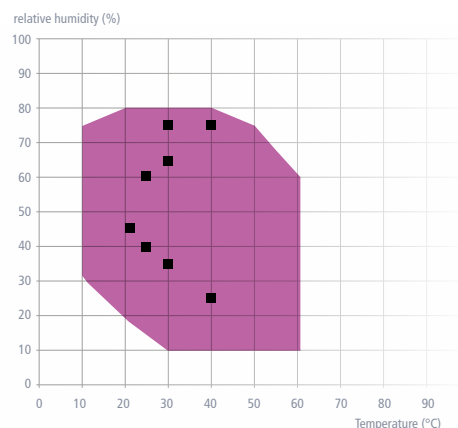

■ Temperature and humidity test points defined in the ICH guideline

Note:

Within the respective temperature-humidity range, condensation-free permanent operation is possible. To which extent condensation may occur in the threshold range depends on the humidity content of the chamber load and the ambient conditions.



CLIMATE CHAMBERS ICH

according to DIN 12880:2007-05, EN 61010-1 (IEC 61010-1), 61010-2-010

Standard units are safety-approved and bear the test marks:



Standard equipment

- Interior: Stainless steel, mat. 1.4301 (ASTM 304), deep-drawn
 Internals: 2 stainless steel grids, electropolished
 Housing: Textured stainless steel, rear zinc-plated steel, intuitively operated TwinDISPLAY (TFT colour display) with touchscreen
 Double doors: Outside stainless steel, fully insulated, inside glass (size 750: two-leaves)
 Connection: Mains cable with plug
 Installation: Mounted on lockable castors
 Interfaces:

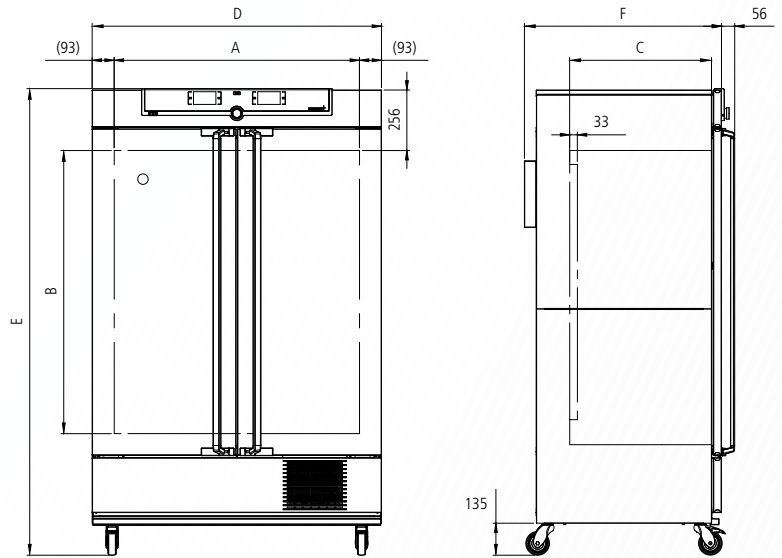
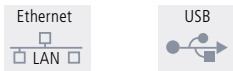

Model sizes/Description			110	260	750	
Stainless steel interior	Volume	approx. l	108	256	749	
	Width	(A) mm	560	640	1040	
	Height	(B) mm	480	800	1200	
	Depth (less 33 mm for fan)	(C) mm	400	500	600	
	Stainless steel grids, electropolished (standard equipment)	number		2		
	Max. number of grids/shelves	number	5	9	14	
	Max. loading per grid/shelf	kg		20	30	
	Max. loading of chamber	kg	150	200		
Textured stainless steel exterior	Width	(D) mm	745	824	1224	
	Height (with castors)	(E) mm	1233	1552	1950	
	Depth (without door handle), door handle + 56 mm	(F) mm	634	734	834	
	Entry port (silicone), 40 mm clear diameter, for introducing connections, moisture tight, can be closed by a silicone stopper, standard position			□		
Further data	Electrical load at 230/115 V, 50/60 Hz ICH and ICH C	approx. W		1350		
	Electrical load at 230/115 V, 50/60 Hz ICH L	approx. W	1450		1530	
	Working temperature range ICH / ICH L with humidity and/or light	°C		+10 to +60		
	Working temperature range ICH C with and without humidity	°C		+10 to +50		
	Working temperature range without humidity ICH (not suitable for long-term storing at sub-zero temperatures. During permanent operation, the glass door may ice over)	°C		-10 to +60		
	Working temperature range without humidity ICH L	°C		0 to +60		
	Setting temperature range ICH	°C		-10 to +60		
	Setting temperature range ICH L	°C		0 to +60		
	Setting temperature range ICH C	°C		+10 to +50		
	Setting accuracy	°C		0.1		
	Adjustment range humidity	% rh		10 to 80		
	Setting accuracy humidity	% rh		0.5		
	Digital electronic CO ₂ control with autozero, NDIR system, with auto-diagnostic system and acoustic fault indication, barometric pressure compensation (only ICH C), adjustment range	% CO ₂		0 to 20		0 to 10
	Control accuracy at 0 – 10 % CO ₂ , at 11 – 15 % CO ₂	%		+/- 0.2 +/- 0.5		+/- 0.3 –
	Setting accuracy CO ₂ (only model ICH C)	% CO ₂		0,1		
illumination unit (only model ICH L) acc. ICH Q1B option 2; separately switchable via controller, one box Number of fluorescent lights with cold white light size 110: 3, sizes 260/750: 4 Number of fluorescent lights with UV lamps all sizes: 2					daylight: light colour 865 6,500 K UV spectral range from 320 to 400 nm (daylight and UV light comply with standard illuminant D65)	
Standard accessories	Water tank including connection hose			□		

Model sizes/Description			110	260	750
Packing data	Net weight	approx. kg	109	160	249
	Gross weight (packed in carton)	approx. kg	137	217	319
	Width	approx. cm	88	93	133
	Height	approx. cm	141	176	215
	Depth	approx. cm	81	93	105
Order No. Climate Chambers			ICH110	ICH260	ICH750
ICH = Climate chamber			ICH110L	ICH260L	ICH750L
ICH L = Climate chamber with light			ICH110C	ICH260C	ICH750C
ICH C = Climate chamber with CO ₂ control					

Options			110	260	750
Voltage 115 V, 50/60 HZ				X2	
Chamber modification for the application of reinforced perforated stainless steel shelves or stainless steel grids (bearing rails mounted in the working chamber) – includes replacement of 2 standard grids by 2 reinforced grids (only ICH and ICH C)			–		K1
Illumination unit (has to be ordered together with the chamber) consisting of 4 fluorescent lights with cold white light (daylight: light colour 865, 6.500 K) and 2 UV lamps in the spectral range of 320 to 400 nm, in accordance with ICH Q1B, option 2 (daylight and UV light comply with standard illuminant D65); separately switchable via controller (only ICH L)		second box	–		T72
Alternative light boxes (replace the standard lighting; have to be ordered together with the chamber); number of fluorescent lamps: size 110: 5, sizes 260/750: 6, with cold white light (daylight: light colour 865, 6.500 K) (only ICH L)		one box	–	T81	
(daylight complies with standard illuminant D65)		second box (cannot be switched on separately)	–		T82
Alternative light boxes (replace the standard lighting; have to be ordered together with the chamber); number of UV lamps: size 110: 5, sizes 260/750: 6 in the spectral range of 320 to 400 nm (only ICH L)		one box	–	T01	
(UV light complies with standard illuminant D65)		second box (cannot be switched on separately)	–		T02
Interior socket, ampacity 230 V/2.2 A, can be switched off with the On/Off switch, cannot be switched individually, moisture tight IP68 (not for ICH110L)				R3	
Entry port, 23 mm clear diameter, for introducing connections at the side, moisture tight, can be closed by flap and silicone stopper, standard positions (F1 and F3 not for models ICH L)		left centre/centre left centre top right centre top	–	F0 F1	F3
Entry port (silicone), 40 mm clear diameter, for introducing connections, moisture tight, can be closed by silicone stopper, at the back (please, state location). Not for models ICH L			–		F7
4 – 20 mA current loop interface (-20 to +70 °C \pm 4 to 20 mA) (Models ICH C max. 2 interfaces – only combination V3 + V7 or V3 + V9 possible)		Temperature controller, actual value Temperature of a Pt100 sensor positioned flexibly in chamber for external temperature monitoring (max. 3 TwinDISPLAY)		V3 V6	
		Humidity controller, actual value (0 – 100 % rh \pm 4 – 20 mA) CO ₂ controller, actual value (0 – 25 % CO ₂ \pm 4 – 20 mA)		V7 V9	
Fan speed monitoring with switching off the heating and with alarm in case of failure				V4	
Works calibration certificate for one (freely selectable) temperature and humidity value Standard works calibration certificate (measuring point chamber centre) at +10 °C, +37 °C and +30 °C with 60 % rh				D00121	
Compressed air dehumidification (efficient dehumidification of the interior by means of compressed air – for models ICH and ICH L) Standard works calibration certificate (measuring point chamber centre) at +10 °C with 10 % rh				C9	

Accessories			110	260	750
Stainless steel grid, electropolished (standard equipment)			E20165	E28891	E20182
Additional reinforced stainless steel grid, electropolished, max. loading 60 kg; size 750 with guide bars and fixing screws (only in connection with option K1). Please consider max. loading of chamber			E29767	E29766	B32190
Stainless steel shelf			B00325	B29725	B00328
Additional reinforced stainless steel shelf, max. loading 60 kg; with guide bars and fixing screws (only in connection with option K1). Please consider max. loading of chamber			–		B32191
Stainless steel slide-in drip tray, 15 mm rim (may affect the temperature distribution) – cannot be used in connection with option K1			E02073	E29726	E02075
Max. loading per slide-in drip tray (kg)			3	4	8
Stainless steel slide-in drip tray, 15 mm rim, with guide bars and fixing screws (can be used only in connection with option K1)			–		B32763
Stainless steel bottom drip tray, 15 mm rim (may affect the temperature distribution) – cannot be used in connection with option K1			B04359	B29722	B04362
Max. loading per bottom drip tray (kg)			3	4	8
Stainless steel bottom drip tray, 15 mm rim (can be used only in connection with option K1)			–		B34055
Holder for water tank (2,5 litres) for mounting on the rear of the appliance. Standard equipment for size 750			E32172		–
Central water supply with filter cartridges for connection to the domestic water supply. Product information on demand				ZWVR6	
Central water supply without filter cartridges for connection to the domestic water supply (only for demineralised water in accordance with VDE 0510/DIN EN 50272). Product information on demand				ZWVR7	

Further options/accessories see pages 20 - 22.

Not all options/accessories are combinable with each other. Please contact us for individual combination requests.



Climatic test chamber CTC
with humidity control
Temperature test chamber TTC
"Celsius" standard software

Model size: 256
- 42 °C to +190 °C (without humidity)
+10 °C to +95 °C (CTC with humidity)
Humidity 10 to 98 % rh (CTC)

CLIMATIC TEST CHAMBER CTC / TEMPERATURE TEST CHAMBER TTC

100% AtmoSAFE: In Memmert environmental test chambers CTC and TTC, the perfect atmosphere for climate and temperature tests, specifically in accordance with IEC 60068 are simulated. Ramp operation, active humidification and dehumidification of 10 to 98 % rh and precise temperature control from -42 °C to +190 °C (without humidity) with humidity control from +10 °C to +95 °C provide unlimited flexibility for controlled material and function tests as well as ageing tests.





Reliable and efficient climate technology

The components of the climate system interact perfectly for quick, precise and energy-saving temperature changes. The 3-layer insulation system for the chamber, derived from aerospace engineering applications, impresses with an excellent K-value and prevents moisture penetration of the insulation material. The electronically controlled injection of refrigerants guarantees an optimal cooling performance and thanks to the automatic defrosting system, the TTC and CTC test chambers run in continuous operation without interruption.



The stainless steel evaporator stands out with a long and corrosion-free life and the twin-compressor, regulated according to the output, saves valuable energy. The temperature-dependent speed-controlled condenser fan ensures low noise level in partial load operation.



Economical at high performance

The high level of standardisation and the highly efficient principle of equal parts in production at Memmert allow an extensive range of standard features, along with constantly excellent quality at an outstanding cost/benefit ratio. However, this high-performance duo proves to be extremely cost-efficient not only in their procurement costs, but also in their operating costs. Thanks to the steam generator and the twin compressor, which is regulated according to the output, the CTC consumes only about half of what standard environmental simulation chambers do in climate control operation.

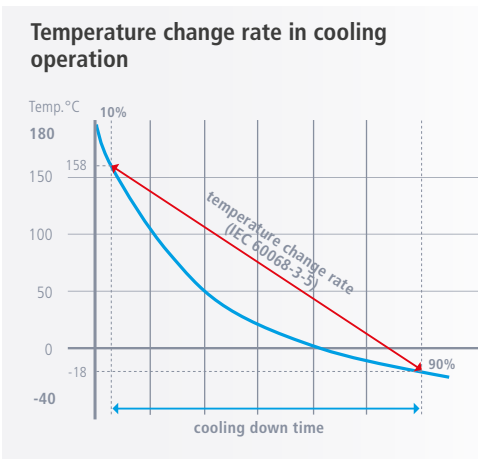

According to Newton's law of cooling, the rate of temperature change follows an exponential curve. The rate of temperature change calculated according to IEC 60068-3-5 applies to cooling from 90 % to 10 %. In the upper temperature range, the rate of temperature change is significantly higher, in the lower temperature range it is significantly lower.

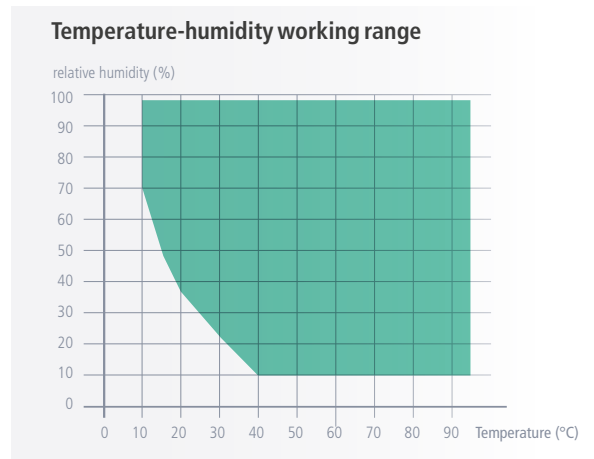

Note:
Within the respective temperature-humidity range, condensation-free permanent operation is possible. To which extent condensation may occur in the threshold range depends on the humidity content of the chamber load and the ambient conditions.

CLIMATIC TEST CHAMBERS CTC – TEMPERATURE TEST CHAMBERS TTC

according to IEC 60068

Standard units are safety-approved and bear the test marks:



Standard equipment

- Interior: Stainless steel, material 1.4301 (ASTM 304)
- Internals: 1 stainless steel grid, electropolished
- Housing: Textured stainless steel, rear zinc-plated steel, aesthetic functional glass-stainless steel operating panel with multifunction display and input module
- Door: Stainless steel, fully insulated, heated
- Connection: Mains cable with plug
- Installation: On lockable castors

Interfaces:

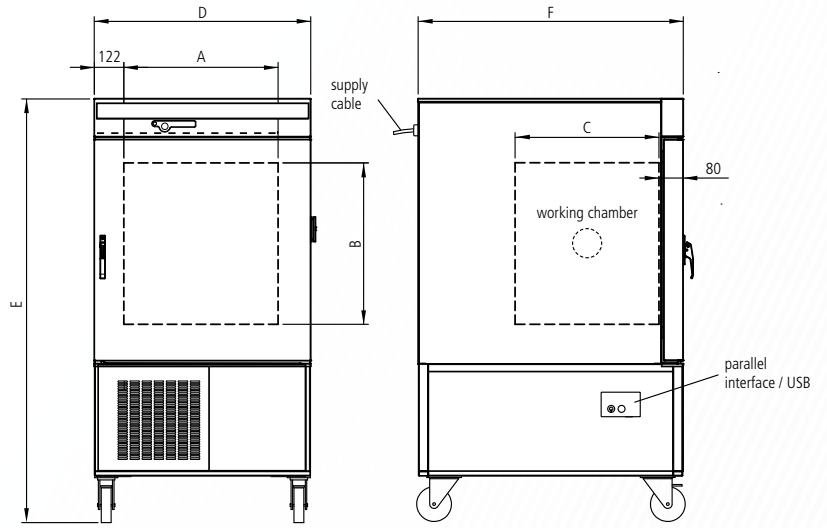
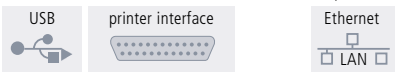

Model sizes/Description		CTC256	TTC256	
Stainless steel interior	Volume	approx. I	256	
	Width (A)	mm	640	
	Height (B)	mm	670	
	Depth (C)	mm	597	
	Support ribs for stainless steel grids	number	6	
	Max. loading per grid	kg	25	
	Max. loading of chamber	kg	100	
Textured stainless steel exterior	Width (plus 20 mm for silicone plug and 5 mm for interfaces) (D)	mm	898	
	Height (E)	mm	1730	
	Depth (without door handle), depth of door handle 50 mm (F)	mm	1100	
	Fully insulated heated stainless steel door		<input type="checkbox"/>	
	Lockable castors for ease of transport		<input type="checkbox"/>	
	Entry port, right, 80 mm with plug		<input type="checkbox"/>	
Temperature	Electronic microprocessor temperature controller with Pt100 and auto-diagnostic system		<input type="checkbox"/>	
	Temperature sensors Pt100 Class A in 4-wire circuit for uninterrupted operation on failure of one Pt100 with warning indication		double	
	Temperature range with humidity control	°C	+10 to +95	–
	Temperature range without humidity control	°C	-42 to +190	
	Setting accuracy	°C	-42 to 99.9: 0.1 / 100 to 190: 0.5	
	Temperature change rate in heating operation (acc. to IEC 60068-3-5) -40 to +180 °C measured at an ambient temperature of 22 °C		10 K / minute	
	Temperature change rate in cooling operation (acc. to IEC 60068-3-5) +180 to -40 °C measured at an ambient temperature of 22 °C		3 K / minute	
	Temperature variation in time acc. to DIN 12880:2007-05 (setpoint dependent of min. temperature up to +150 °C and humidity > 20 %)	K	± 0.2 ... 0.5	
Temperature uniformity in chamber (setpoint dependent of min. temperature up to +150 °C and humidity > 20 %)	K	± 0.5 ... 2		
Humidity	Capacitive humidity sensor	<input type="checkbox"/>	–	
	Active microprocessor control for humidifying and dehumidifying (10 – 98 % rh) incl. digital indication and auto-diagnostic system ensures rapid reaching of set humidity and very short recovery times; humidity supply with distilled water by self-priming pump	<input type="checkbox"/>	–	
	Humidity stability in time	% rh	±1 ... 3	
	Telescopic slide for each 2 x 10 l tanks for distilled water as well as 2 x 10 l tanks as condensate collector	<input type="checkbox"/>	–	
	Automatic water tank change-over with alarm for continuous operation	<input type="checkbox"/>	–	
Monitor	Microprocessor temperature monitor acting as over- and undertemperature protection (protection class 3.3), with Pt100 incorporating fault diagnostics with visual and acoustic alarm	<input type="checkbox"/>		
	Temperature monitoring band automatically linked to the setpoint (ASF)	<input type="checkbox"/>		
	Monitor relay for reliable heating cut-off in case of fault	<input type="checkbox"/>		
	Mechanical temperature limiter (TB)	<input type="checkbox"/>		

Model sizes/Description		CTC256	TTC256
Acoustic and optical alarm	Over- and undertemperature		<input type="checkbox"/>
	Door-open		<input type="checkbox"/>
	Underhumidity	<input type="checkbox"/>	–
	Empty water tank	<input type="checkbox"/>	–
Timer functions	Real-time/weekly programmer with group function (e.g. Monday – Friday)		<input type="checkbox"/>
	Timer with residual running time: max. 40 ramps (each 1 min. up to 999 h) programmable through controller or MEMoryCard XL; programming via PC and free-of-charge software: unlimited number of ramps		<input type="checkbox"/>
Air Circulation	High-performance air fan, speed adjustable in 10 % steps with monitoring function of fan speed and automatic speed adjustment		<input type="checkbox"/>
Documentation	Internal log memory 1024 kB as ring memory for all setpoints, actual values, errors, settings with real-time and date; capacity approx. 3 months (CTC) resp. 6 months (TTC) at 1 min. intervals		<input type="checkbox"/>
	Parallel printer interface for printing logging files, suitable for all PCL3-compatible ink jet printers (USB available via converter, see accessories)		<input type="checkbox"/>
	“Celsius” software for control and documentation of temperature and relative humidity		<input type="checkbox"/>
Setup	Calibration (no separate PC required), temperature: 3-point calibration on controller		<input type="checkbox"/>
	Calibration (no separate PC required), humidity: 2-point calibration at 20 % and 90 %	<input type="checkbox"/>	–
	Setting of language for dialogue and display DE / EN / ES / FR / IT		<input type="checkbox"/>
Refrigeration	High-performance twin compressor (refrigerant R404A) with adjustable speed condenser fan and electronically controlled refrigerant injection		<input type="checkbox"/>
	Large-area stainless steel evaporator		<input type="checkbox"/>
Lighting	Halogen interior lighting 2 x 25 W		<input type="checkbox"/>
Further data	Electrical load at 400 V/50 Hz	approx. W	7000
Standard accessories	Stainless steel grid	number	1
	Works calibration certificate (measuring point chamber centre at -20 °C and +160 °C)		<input type="checkbox"/>
	Works calibration certificate (measuring point chamber centre at +30 °C and 60 % rh)	<input type="checkbox"/>	–
Packing data	Net weight	approx. kg	337
	Gross weight	approx. kg	463
	Width	approx. cm	102
	Height	approx. cm	191
	Depth	approx. cm	131
Order No. Climatic Test Chambers		CTC256	–
Order No. Temperature Test Chambers		–	TTC256

Options	CTC256	TTC256
Works calibration certificate for one temperature and humidity according to customer specification		D00110
Door hinged on the left		B8
Full-sight glass door (5-layer insulating glazing), heated		B0
Entry port, left, 80 mm, with stopper		F0
Start-up of CTC and TTC chambers and brief training (D, A, CH only) through Memmert service		K9

Accessories	CTC256	TTC256
Additional stainless steel grid, electropolished		E20591
External control and logging package consisting of mini-Notebook and software “Celsius”, pre-configured, and lateral swinging arm		B04410

DECISION-MAKING-AID

Temperature/humidity combinations of Memmert climate chamber*

100% AtmoSAFE: Made by Memmert. As decision-making-aid for the right climate chamber, this graph shows all temperature/humidity combinations of the Memmert climate chambers.

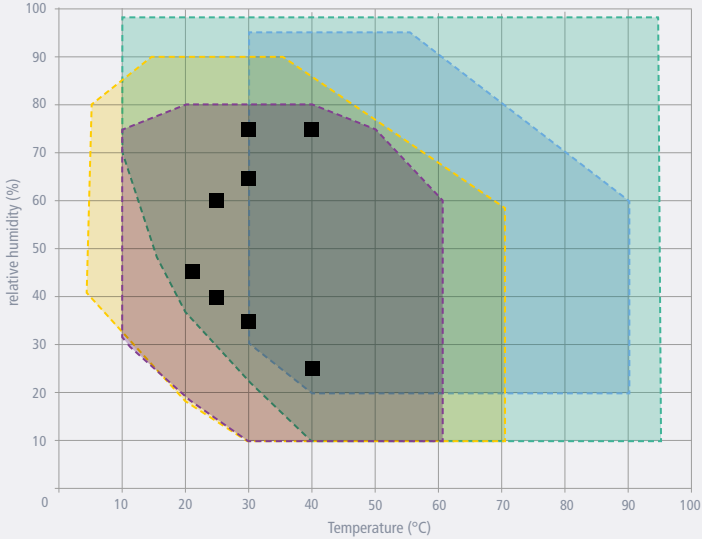

- HPP constant climate chamber (page 4 to 7)
- HCP humidity chamber (page 8 to 11)
- ICH climate chamber (page 12 to 15)
- CTC environmental test chamber (page 16 to 19)
- Temperature and humidity test points defined in the guideline ICH

Relying on perfectly controlled processes

Active humidification and dehumidification are essential to exactly reach the desired set temperatures and set humidity values, also in areas with high ambient temperature and extremely high or low air humidity.

Furthermore, to guarantee long term homogeneity, interaction between humidity and temperature control has been perfectly adjusted in all Memmert climate chambers.

* Note: Within the respective temperature-humidity range, condensation-free permanent operation is possible. To which extent condensation may occur in the threshold range depends on the humidity content of the chamber load and the ambient conditions.

The higher the humidity content of the chamber load, the more water evaporates inside the chamber. This may influence the maintenance of the constant humidity considerably. If you need constant stable operation at the edges or the chamber load is very humid, we recommend dehumidifying with compressed air. We also have other technical solutions for special needs that guarantee stable operation. Send us your inquiry!

SPECIAL EQUIPMENT FOR MODELS U, UF TS, UNpa, S, I, ICP, IPP, IPS, HPP, ICH **ICOMed**

Options for models U, UF TS, UNpa, S, I, ICP, IPP, IPS, HPP, ICH	30	55	75	110	160	260	400	450	750	1060	1400	50 / 105 / 150 / 240
Door with lock (safety lock); for models UF TS per side; standard with SN/SF and SNplus/SFplus 450 and 750 (not for models ICOMed)	B6						-					
Door hinged on the left; for models UF TS per side	B8						B8					
Potential-free contact (24 V/2 A) with socket to NAMUR NE 28 for external monitoring (indicates when setpoint is reached); models ICOMed: when set points of temperature and CO ₂ are reached							H5					
Potential-free contact for combination error message (e.g. supply failure, sensor fault, fuse)							H6					
Potential-free contact (24 V/2 A) with socket to NAMUR NE 28, for signal generation, controlled by programme segment, for free-selectable functions to be activated (e.g. activation of audible and visual signals, exhaust motors, fans, stirrers, etc.). Only for units with TwinDISPLAY; max. 2 contacts on 1-phase appliances; max. 4 contacts on 3-phase appliances (not for models ICOMed)					2 contacts 4 contacts		H72		H74		-	
Process-dependent door lock (only for units with TwinDISPLAY); for models UF TS see page 11 of oven brochure; not for models ICOMed	D4						-					
Door-open-recognition, incl. alarm, shuts down fan and after 30 sec. also heating (only for units with TwinDISPLAY); for models UF TS per side; standard with ICOMed, ICH C, ICH L	V5						-					
Flexible Pt100 for positioning in chamber or in load with socket, 4-pin, according to NAMUR NE 28, for external temperature recording (load temperature) max. 3 sensors; not for models ICOMed							H4					
Flexible Pt100 temperature sensor, positioned flexibly in chamber or load, for local temperature measurement (up to 3 additional sensors are possible). The measured temperature can, if required, be indicated on the display, recorded in the integral data store, and can be documented via the AtmoCONTROL software. Not for models ICOMed							H8					
MobileALERT, notification by SMS in case of any error or alarm of the device. Requires option H6 "floating contact for alarm"							C3					
MobileALERT for up to 4 alarm notifications; standard: temperature and CO ₂ alarm, additionally humidity alarm (when equipped with option K7) and O ₂ alarm (when equipped with option T6)							C4					
Temperature restriction (for UN/UF/UNplus/UFplus/UNm/UFm/UNmplus/UFmplus and models UF TS); Temperatures: +60, +70, +80, +95, +100, +120, +160, +180, +200, +220 or +250 °C (Please, indicate upon ordering)	A8						A8		-			
Castor frame (2-part), height 140 mm (not for models UF TS, ICP, ICH, ICH L, ICH C, ICOMed)	R9						-					

SPECIAL EQUIPMENT FOR MODELS U, UF TS, UNpa, S, I, ICP, IPP, IPS, HPP, ICH													ICOMed	
Accessories for models U, UF TS, UNpa, S, I, ICP, IPP, IPS, HPP, ICH	30	55	75	110	160	260	400	450	750	1060	1400	50 / 105 / 150 / 240		
USB-Ethernet adapter												E06192		
Ethernet connection cable 5 m for computer interface												E06189		
USB User-ID stick (with User-ID licence): Oven-linked authorisation licence (User-ID-programme) on Memory-stick, prevents undesired manipulation by unauthorised third parties. When reordering please specify serial number (only for units with TwinDISPLAY)												B33170		
USB stick with documentation software AtmoCONTROL and operation manual for products with SingleDISPLAY (the standard equipment of appliances with TwinDISPLAY includes one USB stick with AtmoCONTROL)												B33171		
Set of height adjustable feet (4 pcs) not available for ICP, ICH, ICH L, ICH C – standard on models ICOMed				B29768								–		
Stacking set (4 pcs) for stacking of appliances of same size (not for models 160, 260, 450, 750, 1060, 1400, ICH110, ICH110L, ICH110C, ICP55, ICP110)		B29744						–				B29744	–	
Stacking set (consisting of stacking corners, one connecting plate for the rear, two wall brackets) for stacking two units ICO150med or ICO240med								–					B42114 (150) B42115 (240)	
Plug-in tube extension (outer diam. 60.3 mm, inner 57 mm), straight, for exhaust air ducting (if necessary for connection by hose), only models U, I, S not for models UF TS							B29718						–	
Plug-in tube extension (outer diam. 60.3 mm, inner 57 mm), angled, for exhaust air ducting (if necessary for connection by hose), only models U, I, S not for models UF TS							B29719						–	
Flush-fit unit (stainless steel frame covering gap between oven and wall opening), with air slots	B29728	B29730	B29732	B29734	B29736	B29738	B42116	B29740	B29742	B42118			–	
Flush-fit unit (stainless steel frame covering gap between oven and wall opening), without air slots for models UF TS see page 11 of oven brochure; not for models ICOMed	B29729	B29731	B29733	B29735	B29737	B29739	B42117	B29741	B29743	B42119			–	
Subframe, adjustable in height (size 30 to 75: height 600 mm, size 110 to 450: height 500 mm); not for models ICOMed, UF TS and HPP400	B29745	B29747		B29749	B29751	–	B29753					–		
Subframe, on castors (size 30 to 75: height 660 mm, size 110 to 160: height 560 mm); not for models ICOMed and UF TS	B29746	B29748		B29750							–			
Subframe, adjustable in height, height 130 mm, for example for units with fresh air filter; not for models ICOMed and UF TS	B33657	B33659		B33661	B33664						–			
Software conforming to FDA AtmoCONTROL. Meets the requirements for the use of electronically stored data sets and electronic signatures as laid down in Regulation 21 CFR Part 11 of the US Food and Drug Administration (FDA). Base licence for the control of one unit (only for units with TwinDISPLAY)													FDAQ1	
Integration of additional units (up to max. 15 units) into an already existent FDA-software licence (only for units with TwinDISPLAY)													FDAQ2	
IQ document with device-specific works test data, OQ/PQ check list as support for validation by customer													D00124	
IQ/OQ document with device-specific works test data for one free-selectable temperature value, incl. temperature distribution survey at Memmert for 9 measuring points (size 30), 27 measuring points (sizes 55 – 1060) to DIN 12880:2007-05, PQ check list as support for validation by customer. Further temperature values and validation at customer site on demand	D00125												D00127	–
IQ/OQ document with device-specific works test data for one free-selectable temperature and humidity value, incl. temperature distribution survey at Memmert for 27 measuring points (26 measuring points on model HPP1400) to DIN 12880:2007-05, PQ check list as support for validation by customer (models HPP and ICH). Validation at customer site on demand		–		D00136	–		D00136	–		D00136			–	
IQ/OQ document with device-specific works test data for one free-selectable temperature, humidity and light value, incl. temperature distribution survey at Memmert for 27 measuring points to DIN 12880:2007-05, PQ check list as support for validation by customer (models HPP with light and ICH L). Validation at customer site on demand		–		D00137	–		D00137	–		D00137			–	
IQ/OQ document with device-specific works test data for one free-selectable CO ₂ , humidity and temp. value, incl. temp. distribution survey at Memmert for 27 measuring points to DIN 12880:2007-05, PQ check list as support for validation by customer (models ICH C and ICOMed, on models ICOMed a free-selectable humidity value is only possible with option K7). Validation at customer site on demand		–		D38897	–		D38897	–		D38897	–		D38897	
IQ/OQ document with device-specific works test data for one free-selectable CO ₂ and temperature value, incl. temperature distribution survey at Memmert for 27 measuring points to DIN 12880:2007-05, PQ check list as support for validation by customer (model ICOMed). Validation at customer site on demand							–						D38898	
External measuring instrument with sensors for daylight and UV-light. Product information on demand (models HPP, ICH L, IPPplus)						B04713				–	B04713		–	
Ditto with additional measuring head for temperature and humidity measurement. Product information on demand (models HPP, ICH L, IPPplus)						B04714				–	B04714		–	

Not all options/accessories are combinable with each other. Please contact us for individual combination requests.

SPECIAL EQUIPMENT FOR MODELS VO, VOcool, HCP, TTC, CTC

Options for models VO, VOcool, HCP, TTC, CTC	200	400	500	108	153	246	256
Interface Ethernet instead of USB including software							W4
RS232 interface instead of USB							W6
Computer interface RS485 (for networking a max. of 16 ovens) instead of RS232							V2
Door with lock (safety lock, not available for VO, VOcool, TTC/CTC)							B6
Flexible Pt100 for positioning in chamber or in load with socket, 4-pin, according to NAMUR NE 28, for external temperature recording (load temperature); for VO and VOcool on demand							H4
Additional Pt100 temperature sensor, positioned flexibly in chamber or load, for local temperature measurement (up to 3 additional sensors are possible). The measured temperature can, if required, be indicated on the multifunction display, recorded in the integral ring store, and can be documented via the "Celsius" software or on an attached printer. (Not available for VO, VOcool, TTC and CTC)							H8
Potential-free contact (24 V/2 A) with socket, according to NAMUR NE 28 for external monitoring (indicates when setpoint is reached)							H5
Potential-free contact (24 V/2 A), with socket, according to NAMUR NE 28 for combination error message (e.g. supply failure, sensor fault, fuse)							H6
Potential-free contact (24 V/2 A), with socket, according to NAMUR NE 28, triple, for signal generation, controlled by programme segment for a total of 3 freely selected functions to be activated (e.g. acoustic and visual signals, exhaust motors, fans, stirrers etc.). Not available for VO, VOcool							H7
MobileALERT, notification by SMS in case of any error or alarm of the device. Requires option H6 "floating contact for alarm"							C3

Accessories for models VO, VOcool, HCP, TTC, CTC	200	400	500	108	153	246	256
USB connection cable for computer interface							E03643
Parallel/USB converter cable with integrated power supply unit to connect HP printers with USB interface to MEMMERT units							E05300
Documentation package consisting of parallel USB converter cable including PCL3-compatible HP colour inkjet printer with USB interface (HP OfficeJet 6000 or successor) for direct connection of printer to Memmert unit							B04432
Temperature profile write/read unit for programming via PC, for writing to and reading from the chip card, up to 40 ramps							E05284
Additional chip card, blank, formatted (32 kB MEMoryCard XL for a maximum of 40 ramps)							E04004
Oven-linked authorisation card (User-ID-Card) prevents undesired manipulation by unauthorised third parties. When reordering please specify serial number							E04159
Software conforming to FDA "Celsius FDA Edition". Meets the requirements for the use of electronically stored data sets and electronic signatures as laid down in Regulation 21 CFR Part 11 of the US Food and Drug Administration (FDA). Base licence for the control of one unit							E05019
Integration per additional unit (up to max.15 units) into an already existent FDA-software licence (E05019)							FDAQ4
IQ check list with device-specific works test data as support for validation by customer							D00103
OQ check list with device-specific works test data for one free-selectable temperature value, incl. temperature distribution survey at Memmert for 27 measuring points to DIN 12880:2007-05 as support for validation by customer. Validation at customer site on demand							D00104
OQ check list with device-specific works test data for one free-selectable temperature value, incl. temperature distribution survey at Memmert for 5 measuring points to DIN 12880:2007-05 as support for validation by customer valid for one thermoshelf; ditto for further thermoshelves VO on demand (VO and VOcool only). Validation at customer site on demand							D00117
OQ check list with device-specific works test data for one free-selectable humidity and temperature value, incl. temperature distribution survey at Memmert for 27 measuring points to DIN 12880:2007-05 as support for validation by customer (models HCP and CTC). Validation at customer site on demand							D00104
External measuring instrument with sensors for daylight and UV-light, with additional measuring head for temperature and humidity. Product information on demand (models HCP)							B04714

MODEL VARIANTS

SingleDISPLAY ControlCOCKPIT with one TFT display	TwinDISPLAY ControlCOCKPIT with two TFT displays
<p>AVAILABLE APPLIANCES</p> <p>UN/UNm / UF/UFm / IN/INm / IF/IFm / SN / SF / IPP / IPS</p>	<p>AVAILABLE APPLIANCES</p> <p>UNplus/UNmplus / UFplus/UFmplus / UF TS / UNpa INplus/INmplus / IFplus/IFmplus / SNplus / SFplus ICOMed / IPPplus / ICP / HPP / ICH</p>
<p>One high-resolution TFT colour display with touch-sensitive buttons for selection of functions</p>	<p>Two high-resolution TFT colour displays with touch-sensitive buttons for selection of functions</p>
<p>Available parameters on the ControlCOCKPIT: Temperature (Celsius or Fahrenheit), fan speed, exhaust air flap position, programme time</p>	<p>Available parameters on the ControlCOCKPIT: Temperature (Celsius or Fahrenheit), fan speed, exhaust air flap position, programme time, relative humidity, illumination, CO₂</p>
<p>One temperature sensor Pt100 DIN class A in a 4-wire circuit</p>	<p>Two Pt100 sensors DIN class A in a 4-wire circuit for mutual monitoring, taking over functions in case of an error</p>
	<p>HeatBALANCE function for application specific adjustment of heat output distribution (balance) between the upper and lower heating groups in an adjustment range between -50 % and +50 % (not valid for models 30, HPP110, IPP110plus, ICP, ICH)</p>
<p>AtmoCONTROL software for reading out, managing and organising the data logger via Ethernet interface (temporary trial version can be downloaded). USB stick with AtmoCONTROL software available as accessory (on demand)</p>	<p>AtmoCONTROL software on a USB stick for programming, managing and transferring programmes via Ethernet interface or USB port</p>
	<p>ControlCOCKPIT with USB port for uploading programmes, reading out protocol logs, activating the User-ID function</p>
	<p>Displaying of already logged protocol data on the ControlCOCKPIT (max 10,000 values correspond to approx. 1 week)</p>
<p>Ethernet interface on the rear of the appliance for reading out the protocol log and for online logging</p>	<p>Ethernet interface on the rear of the appliance for reading out the protocol log and for uploading programmes and for online logging</p>
<p>Double overtemperature protection: Electronic temperature monitoring with freely adjustable monitoring temperature, for models U, I, S with option A6 TWW/TWB (protection class 3.1 or 2), mechanical temperature limiter TB acc. to DIN 12880</p>	<p>Multiple overtemperature protection: Electronic temperature monitoring TWW/TWB (protection class 3.1 or 2 resp. 3.3 for units with active cooling) and mechanical temperature limiter TB (protection class 1) acc. to DIN 12880, AutoSAFETY automatically adjusts to the set value within a freely adjustable tolerance range. Setting individual MIN / MAX values for over/undertemperature alarm and also for all other parameters such as relative humidity, CO₂</p>
<p>PID microprocessor control with integrated auto-diagnostic system</p>	
<p>Structured stainless steel housing, scratch-resistant, robust and durable; rear of zinc-plated steel</p>	
<p>High-temperature connectors on the rear of the appliance for single-phase power connection according to country specific systems and IEC standards</p>	
<p>Internal data logger with a storage capacity of at least 10 years</p>	
<p>German, English, French, Spanish, Polish, Czech, Hungarian language settings available on the ControlCOCKPIT</p>	
<p>Digital backwards counter with target time setting, adjustable from 1 minute to 99 days</p>	
<p>The SetpointWAIT function guarantees that the process time does not start until the set temperature is reached at all measuring points – optional for temperature values recorded by the freely positionable Pt100 sensors inside the chamber</p>	
<p>Adjustment of three calibration values for temperature and additional appliance specific parameters directly at the ControlCOCKPIT</p>	



memmert
Experts in Thermostatics

HEATING AND DRYING OVENS

UNIVERSAL OVEN U

PASS-THROUGH OVEN UF TS

PARAFFIN OVEN UNpa

STERILISER S

VACUUM OVEN VO

COOLED VACUUM OVEN VOcool

INCUBATORS

INCUBATOR I

CO₂ INCUBATOR ICOmed

COMPRESSOR-COOLED INCUBATOR ICP

PELTIER-COOLED INCUBATOR IPP

COOLED STORAGE INCUBATOR IPS

CLIMATE CHAMBERS

CONSTANT CLIMATE CHAMBER HPP

HUMIDITY CHAMBER HCP

CLIMATE CHAMBER ICH

ENVIRONMENTAL TEST CHAMBER CTC/TTC

WATERBATHS / OILBATHS

WATERBATH W

OILBATH O

YOUR MEMMERT PARTNER

Memmert GmbH + Co. KG
P.O. Box 1720 | D-91107 Schwabach
Tel. +49 9122 925-0 | Fax +49 9122 14585
E-Mail: sales@memmert.com
facebook.com/memmert.family
The platform for experts: www.atmosafe.net